

## **SSRMAN-1P SERIES USERS MANUAL**

### SSR INTELLIGENT PHASE ANGLE CONTROL MODULE

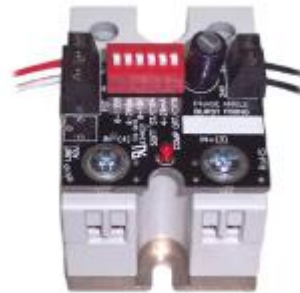

**TABLE OF CONTENTS**

1.	Ordering Codes.....	3
2.	Description .....	3
2.1	Features.....	3
3.	Installation / Safety Information.....	3
3.1	Solid State Relay Installation .....	4
3.2	Mounting Instructions.....	4
3.3	Electrical Connections .....	4
3.3.1	Internal Diagram .....	5
3.4	SSR Output Snubbers and Transient Protection .....	5
3.4.1	Solid State Relays (SSRs).....	5
3.4.2	Commutation Problems .....	5
3.4.3	dv/dt Problems.....	6
3.4.4	Snubber Design .....	6
3.4.5	Snubber Suppliers .....	6
3.4.6	Snubber Sizing .....	6
3.4.7	MOVs and TVSs.....	6
3.5	Limited Warranty.....	6
4.	Operation .....	6
4.1	Power Supply.....	6
4.2	24V Power Fusing.....	7
4.3	Command Input .....	7
4.4	PWM Command Input .....	7
4.4.1	Input Fail-safe Protection.....	7
4.5	Line Voltage Compensation.....	7
4.6	Soft Start.....	8
4.7	Voltage Limit .....	8
4.7.1	Voltage Limit Adjustment Procedure .....	8
4.8	Configuration Dipswitch .....	9
4.9	Control Output .....	9
4.10	Output LED .....	10
4.11	Three Phase Operation .....	10
4.11.1	Three Phase Special Wiring Considerations .....	10
4.11.2	Three Phase Wiring of Command Inputs .....	10
4.12	Wiring Multiple Units in Single Phase Applications.....	11
4.12.1	Connecting Power & Commands In Parallel.....	11
5.	Electrical Specifications .....	12
6.	Mechanical Dimensions .....	12
7.	Contact Information.....	12
8.	WIRING DIAGRAM (4-20mA, 0-5V, 0-10V Inputs).....	13
9.	WIRING DIAGRAM (Potentiometer Input).....	13
10.	WIRING DIAGRAM (0-135 Ohm Input).....	14
11.	WIRING DIAGRAM (PWM Input).....	14
12.	WIRING DIAGRAM 3 PHASE 4 WIRE Y CONNECTION .....	14
13.	WIRING DIAGRAM 3 PHASE INSIDE DELTA.....	15

## 1. Ordering Codes

Part#	Description	Inputs
SSRMAN-1P	SSR Mount Phase Angle Control Module, Volts, mA Input, Pot	0-10V, 0-5V, 2-10V, 1-5V, 4-20mA, 0-20mA, Potentiometer
SSRMAN-1P-VL	SSR Mount Phase Angle Control Module, Volts, mA Input, Pot, Voltage Limit Option	0-10V, 0-5V, 2-10V, 1-5V, 4-20mA, 0-20mA, Potentiometer
SSRMAN-1P-135	SSR Mount Phase Angle Control Module, 0-135Ω Input	0-135Ω
SSRMAN-1P-REV	Reverse Acting Output Option	0-10V, 0-5V, 2-10V, 1-5V, 4-20mA, 0-20mA, Potentiometer
SSRMAN-1P-XSS	X Second Soft Start Time, where X is choice of 2-18 seconds Default is 20 Seconds when -XSS is omitted	0-10V, 0-5V, 2-10V, 1-5V, 4-20mA, 0-20mA, Potentiometer
SSRMAN-1P-FR	SSR Mount Phase Angle Control Fast Response, No LV Comp.	0-10V, 0-5V, 2-10V, 1-5V, 4-20mA, 0-20mA, Potentiometer

## 2. Description

The SSRMAN-1P is a phase angle control module designed for use with standard footprint random fire SSRs (Solid State Relays). The module mounts directly on the SSR's input screws. The module operates by varying the firing point of the SSR's input. The power delivered to the load is proportional to the command input signal. The SSRMAN-1P will not operate correctly with zero cross fired SSRs.

### 2.1 Features

- Provides true linear power output phase angle control
- Small (1.75x1.40") module mounts on the input terminals of an inexpensive SSR
- Command input accepts 4-20mA, 0-10V, 0-5V, 0-135 Ω, Pot, PWM
- Configurable line voltage compensation increases stability of your process
- Configurable soft start for high inrush loads
- Automatic 50/60Hz operation
- Adjustable Voltage Limit (-VL) Option
- Drives multiple solid state relays
- Single phase and three phase control

## 3. Installation / Safety Information

Responsibility for determining suitability for use in any application / equipment lies solely on the purchaser, OEM and end user. Suitability for use in your application is determined by applicable standards such as UL, cUL and CE and the completed system involving this component should be tested to those standards.



**WARNING: FIRE HAZARD!!** Even quality electronic components CAN FAIL KEEPING FULL POWER ON! Provide a SEPARATE (redundant) OVER TEMPERATURE SHUTDOWN DEVICE to switch the power off if safe temperatures are exceeded.



**WARNING: HIGH VOLTAGE!!** This control is installed on a Solid State Relay with high voltage on it. This control must be installed in a GROUND<sup>ED</sup> enclosure by a qualified electrician in accordance with applicable local and national codes including NEC and other applicable codes. Provide a safety interlock on the door to remove power before gaining access to the device.

### 3.1 Solid State Relay Installation

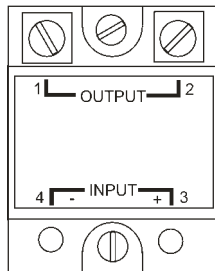

Make sure that the voltage and current ratings of the Solid State Relay (SSR) are sized correctly for the load, otherwise a hazardous condition such as over-heating, failure of the SSR, fire or explosion may result. Contact the SSR manufacturer for more details.



The SSR must be mounted to a heat sink as per the SSR manufacturer's requirements, otherwise a hazardous condition such as over-heating, failure of the SSR, fire or explosion may result. Contact the SSR manufacturer for more details.

### 3.2 Mounting Instructions

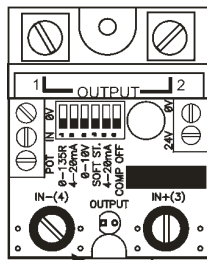

SSRMAN SHOULD BE ORIENTED AS SHOWN AND SCREWED TIGHT TO INPUT TERMINALS

The SSRMAN mounts directly to the control input terminals of an SSR using two #6-32 screws. Some relays have short input screws and longer screws will be required to reach through the contacts on the SSRMAN.

Be sure to observe the correct polarity when mounting the module (module should be positioned over the SSR). The module should sit firmly on top of the SSR when the screws are tightened.

### 3.3 Electrical Connections

See the WIRING DIAGRAMS at the end of this document. Make sure the module ordered is the correct module for the application before wiring.

Before wiring the module all Dip Switch settings for the command input and special features should be setup properly per the

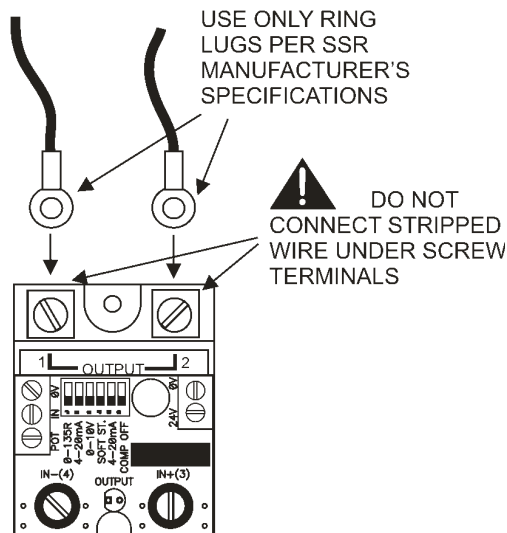

Dipswitch Configuration Section.

The terminal blocks on the sides of the SSRMAN for connecting 24V Power and the command signal can accept 16-30 AWG wire.

**3.3.1 Internal Diagram**

Please reference the internal diagram below to be absolutely sure the system wiring will be compatible with the control module.

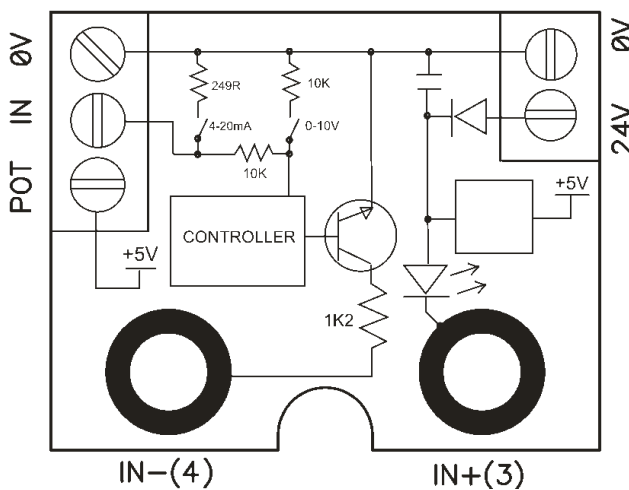

**3.4 SSR Output Snubbers and Transient Protection**

**3.4.1 Solid State Relays (SSRs)**

AC output SSRs use either SCRs or TRIACS internally and even though many SSRs have internal snubber networks, we have found these to be insufficient for use in many inductive load applications. The addition of external properly sized snubbers has improved performance in many applications we have encountered.

**3.4.2 Commutation Problems**

When an SCR or TRIAC is used to control an inductive load, the load current lags the mains voltage. When the device turns off at zero current, the rate of rise of the reapplied voltage can retrigger the device and produce half cycling and blown fuses. To limit this rate of rise and obtain reliable commutation, an R-C (resistor-capacitor) snubber circuit should be connected in parallel with the SCR/TRIAC.

### 3.4.3 dv/dt Problems

When voltage transients occur on the mains supply or load of an SCR/TRIAC it can cause the device to turn on unexpectedly due to the fast rate of rise of voltage (dv/dt). This can result in false firing and half cycling of the load that can cause blown fuses when driving inductive loads. An R-C snubber circuit will help to limit the dv/dt seen by the device and will produce more reliable firing.

### 3.4.4 Snubber Design

Although most designers use an empirical approach to solving the aforementioned issues with snubbers, a number of great articles have been published on the mathematical basis for calculating snubber circuit values such as this one by ST Microelectronics: <http://www.st.com/stonline/books/pdf/docs/6785.pdf>

### 3.4.5 Snubber Suppliers

ITW/Paktron produces cost effective compact snubber networks: [http://www.paktron.com/pdf/Quencharc\\_QRL.pdf](http://www.paktron.com/pdf/Quencharc_QRL.pdf)

### 3.4.6 Snubber Sizing

When an SCR/TRIAC using an R-C snubber turns on, the capacitor is discharged through the resistor into the device resulting in high peak currents. It is critically important when sizing your snubber to make sure that the resistor value does not become so low that the ratings of the SCR/TRIAC are exceeded when the capacitor is discharged.

### 3.4.7 MOVs and TVSs

Metal Oxide Varistors and Transient Voltage Suppressors are both used on TRIACS/SCRs to “clamp” voltage spikes that can occur across the devices and damage them. Snubbers are not a substitute for MOVs/TVSs and vice versa. Snubbers and MOVs/TVs should be used together to get reliable performance and long life from the SCR/TRIAC application.

## 3.5 Limited Warranty

NuWave Technologies, Inc. warrant this product to be free from defect in workmanship and materials for a period of two (2) years from the date of purchase.

1. Should unit malfunction, return it to the factory. If defective it will be repaired or replaced at no charge.
2. There are no user serviceable parts on this unit. This warranty is void if the unit shows evidence of being tampered with or subjected to excessive heat, moisture, corrosion or other misuse / misapplication.
3. Components which wear or damage with misuse are excluded, e.g. relays.
4. NuWave Technologies, Inc. shall not be responsible for any damage or losses however caused, which may be experienced as a result of the installation or use of this product. NuWave Technologies, Inc. liability for any breach of this agreement shall not exceed the purchase price paid E. & O.E.

## 4. Operation

### 4.1 Power Supply

The SSRMAN-1P power requirement is 24V AC +/-15% 47-63Hz. The module will not operate from a 24VDC power supply since it relies on the 24VAC supply for synchronization to the AC line. The 24VAC power input integrity is critical to the proper operation of the SSRMAN-1P. Noise or distortion of this power will affect the zero cross timing and thus accuracy of the output, especially in three phase applications. Using a split bobbin transformer for the 24VAC supply is recommended.

## 4.2 24V Power Fusing

Fusing may be accomplished by fusing each module separately or fusing groups of the modules with either primary or secondary fusing. The current draw of each SSRMAN-1P is 65mA max.

## 4.3 Command Input

The SSRMAN-1P can accept 4-20mA, 0-10V, 0-5V, and Potentiometer and PWM inputs. The SSRMAN-1P-135 can only accept 0-135  $\Omega$  inputs and the SSRMAN-1P-PWM can only accept PWM inputs. All command inputs are not isolated from the 24VAC power input. The type of command input can be configured via the dipswitch. The default setting is 0-5V/potentiometer.

When wiring multiple SSRMAN-1P's together, follow the guidelines in the Wiring Multiple SSRMAN-1Ps section.

Any leg of the command input can tolerate shorts to the (0V) input. Connecting the 24V AC power to the command input will cause damage to the unit.

When 4-20mA is selected via the dipswitch, a 249 Ohm shunt resistor is present at the command input between the 0V and IN terminals. Be sure not to exceed 20mA DC on the input as damage to the unit may result. If the command input is wired to a 0-20mA or 4-20mA output of another device, the 0V terminal must remain at the same potential as the negative lead of the current output from the other device, otherwise damage to the SSRMAN may result.

## 4.4 PWM Command Input

If the PLC or computer providing the PWM signal has 24V drive and the SSRMAN dipswitches switches are set to 0-10V, full output of the SSRMAN-1P will be obtained at a 42% ~ (10V/24V x100%) duty cycle so rescaling in the PLC software is required. If the PWM command is 5V TTL drive, all of the command dipswitches should be set to off.

If the command is coming from the 5 volt SSR drive of a temperature / process controller, all of the command dipswitches should be set to off and a 1K resistor should be added in parallel with the command input. The output cycle time of the temperature / process controller should be set to as fast as possible (100 or 200mS max) and the soft change switch should be set to on. When using a slow speed PWM per the aforementioned, the module should be ordered with a soft change of at least a 2 seconds to smooth the control output.

### 4.4.1 Input Fail-safe Protection

If the signal sent to the SSRMAN-1P's command input should become electrically open the control output will be forced to an off state.

## 4.5 Line Voltage Compensation

The SSRMAN-1P's line voltage compensation keeps the power relatively constant on the load as the line voltage changes. The line voltage is measured via the 24VAC power applied to the SSRMAN-1P module. To use the line voltage compensation feature properly, the 24VAC power transformer should be fed from the same mains as the load circuit to be controlled as per the wiring diagrams at the end of this document. Line voltage compensation can be enabled or disabled using the configuration dipswitch. The default setting is enabled (switch # 6 is OFF). To disable the Line Voltage Compensation, set switch # 6 to the ON position. Since most 24VAC transformer's voltage run a little bit high the nominal input voltage is approx 26-27VAC. Line voltage compensation works best when using the transformers we sell.

## 4.6 Soft Start

The soft start feature ramps up to the command value over a period of approximately 20 seconds. The soft start time resets if the command value goes to zero (less than 4% of the input range) or power is cycled. Soft start is useful on high inrush heaters such as Quartz, Molybdenum, Tungsten, or Graphite heaters.

Soft Start can be set on or off using the configuration dipswitch. The default setting is off. Soft Start Times below 20 seconds are available and can be ordered by adding a -XSS to the ordering code where X is the time in seconds.

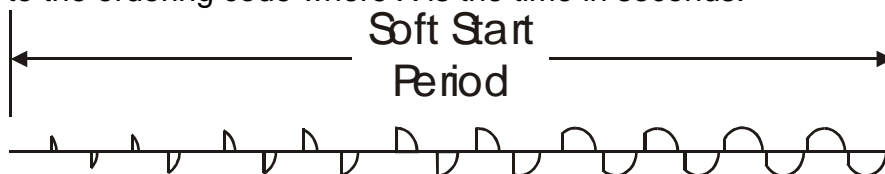

*The Soft Start ramps the voltage up slowly over the soft start period.*

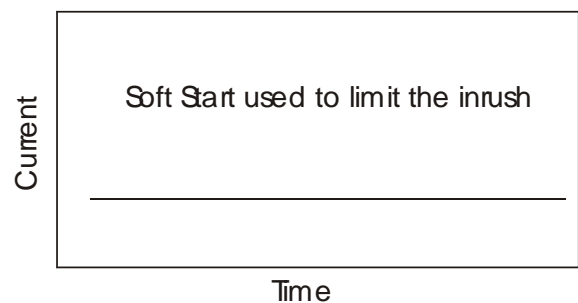
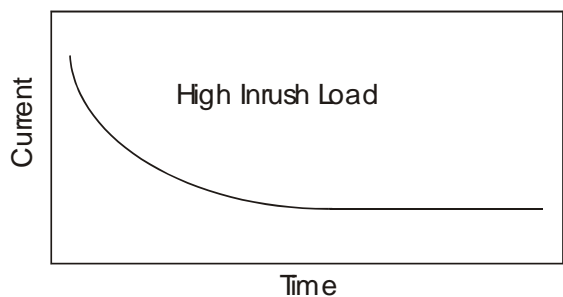

## 4.7 Voltage Limit

The Voltage Limit option can be ordered as SSRMAN-1P-VL. The Voltage Limit feature is used in conjunction with the line voltage compensation feature to limit the actual voltage delivered to the load. The voltage limit is adjustable via a potentiometer located just below the input terminal block. For this feature to work properly, line voltage compensation must be turned on and the power transformer for the SSRMAN-1P must be connected to the same mains as the load power is connected to.

### 4.7.1 Voltage Limit Adjustment Procedure

The Voltage Limit is adjustable from 5% to 100% of the max load voltage. Setting the Voltage Limit potentiometer half way corresponds to a power limit of approximately 55% or a voltage limit of 70% of the max load voltage. The best way to set the voltage limit is using a voltmeter connected across the load. With the command input set to approximately 100% (on startup) turn the pot fully CCW. Then just turn the pot CW until the desired output voltage is achieved. For this feature to work as a true voltage limit, it is important that the Line Voltage Compensation be enabled (this is the OFF position of switch # 6).

If the line voltage compensation is set to OFF the voltage limit will act as a percentage of output limit and the absolute voltage limit will change with line voltage.

#### 4.8 Configuration Dipswitch

The configuration dipswitch is used for setting up the command input, line voltage compensation and soft. Using a pen point gently push the switch up for on and down for off according to the setup outlined in the table below.

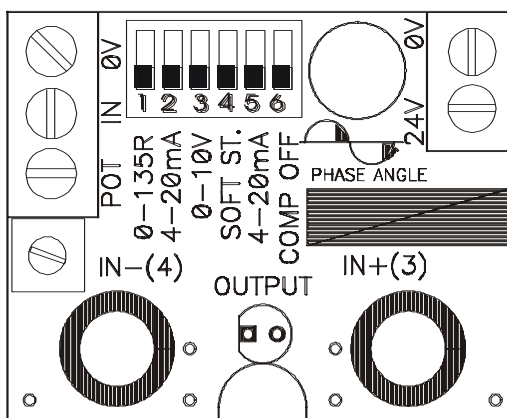

Command Input	1	2	3	5
<b>0-5V (Default)</b>	OFF	OFF	OFF	OFF
<b>Potentiometer</b>	OFF	OFF	OFF	OFF
<b>0-10V</b>	OFF	OFF	<b>ON</b>	OFF
<b>4-20mA</b>	OFF	<b>ON</b>	OFF	<b>ON</b>
<b>1-5V</b>	OFF	OFF	OFF	<b>ON</b>
<b>2-10V</b>	OFF	OFF	<b>ON</b>	<b>ON</b>
<b>0-135Ω*</b>	<b>ON</b>	OFF	OFF	OFF
<b>PWM**</b>	OFF	OFF	OFF	OFF

\*Module must be ordered as SSRMAN-1P-135 for 0-135Ω input support.

\*\*Module must be ordered as SSRMAN-1P-PWM for PWM input support

Feature to Enable	4	6
<b>Line Voltage Comp Enabled (default)</b>	OFF	OFF
<b>None</b>	OFF	<b>ON</b>
<b>Soft Start Only Enabled</b>	<b>ON</b>	<b>ON</b>
<b>Soft Start &amp; Line Voltage Comp Enabled</b>	<b>ON</b>	OFF

#### 4.9 Control Output

The SSRMAN-1P SSR output drive is a DC pulsed current limited 10V/15mA (nominal) drive signal. This is more than enough current for driving most 3-32V standard SSRs, however it is still important to review the data sheet for the SSR you would like to use for compatibility with the SSRMAN-1P's output drive. The control output can tolerate a momentary direct short. The following graph will allow you to verify the SSR's compatibility with the SSRMAN-1P over wide input voltage variations.

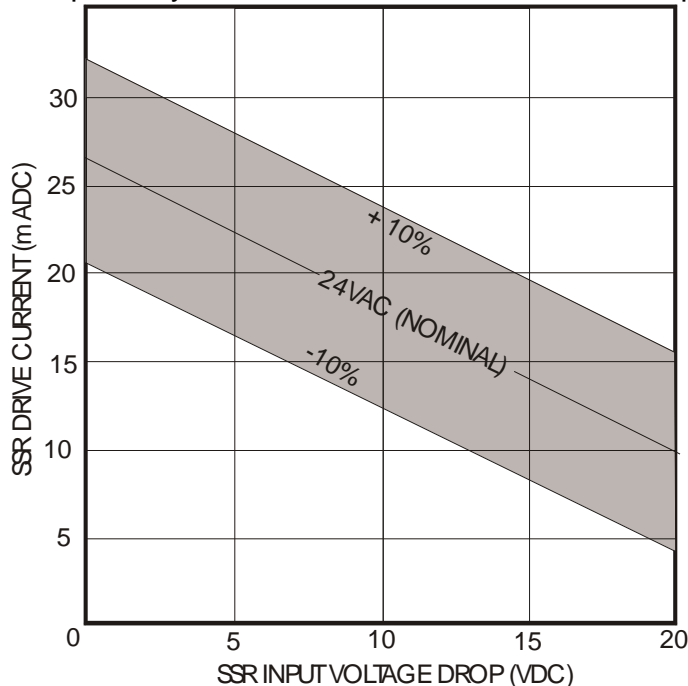

SSRMAN-1P Output Drive Current vs. SSR Input Voltage Drop

## 4.10 Output LED

The SSRMAN-1P's RED output LED will turn on when the output is on and increase in intensity as the power output is increased. Because the drive signal varies considerably to give linear power output, the LED should only be used as a rough indication of SSR Drive and not actual power output. The output LED is wired in series with the SSR's input. If there is a poor connection on the SSR input terminals or a problem with the SSR's Input, the output LED will not become energized.

## 4.11 Three Phase Operation

Three SSRMAN-1Ps can be used to control three poles of a three phase load for inside delta or grounded wye configurations. The Module should be wired as shown in the wiring diagrams, using one transformer for each leg to be controlled.

### 4.11.1 Three Phase Special Wiring Considerations

The SSRMAN-1P derives its AC synchronization from the applied 24VAC power. Each 24VAC transformer's primary must be connected to the corresponding leg power to be controlled by each SSRMAN-1P.

### 4.11.2 Three Phase Wiring of Command Inputs

The command inputs should be connected in parallel if 0-5V or 0-10V is selected and in series if 4-20mA is selected.

## 4.12 Wiring Multiple Units in Single Phase Applications

If more than one SSRMAN-1P is to be used from a non-isolated or common command signals:

1. A common power transformer can be shared. If the input selected is 0-10V or 0-5V, the inputs should be wired in parallel.
2. If multiple units must be powered from one power transformer and 4-20mA input is selected, one module should be set for 4-20mA and the remaining modules should be set for 1-5V.
3. If the command is 4-20mA, and the command inputs are to be wired in series, a separate power transformer for each module is required to isolate the inputs.

### 4.12.1 Connecting Power & Commands In Parallel

When multiple SSRMAN-1P power inputs and commands are wired in parallel, all of the 0V terminals must be connected together follows:

Power:	Command:
0V-----0V-----0V----->	0V-----0V-----0V----->
24V---24V---24V----->	IN-----IN-----IN----->

No crossing of the power input feed or command signal is permitted. If for some reason the power should become crossed, it will cause a direct short in the system. If properly fused, the fuse will blow and the SSRMAN-1P will not be damaged. If the command inputs are wired improperly, damage to SSRMAN-1P can result.

We do not guarantee operation of the SSRMAN-1P with any other manufacturer's SSR control module. Using them in the same circuit may cause either module to be damaged.

## 5. Electrical Specifications

Command Inputs	4-20mA, 0-10V, 0-5V, 0-135 $\Omega$ , Pot, PWM
Input Impedance	10K $\Omega$ (0-10V), 250 $\Omega$ (4-20mA), 100K $\Omega$ (0-5V)
0-135 $\Omega$ Excitation Current	13mA max
Control Output	SSR Drive, DC pulse, nominally 10V at 15mA
Response Time	100mS
PWM Input Period Range	1-5 Seconds
PWM Input Level	5-30VDC
Output Linearity	+/-2%
External Potentiometer Res.	10K $\Omega$ -25K $\Omega$
Line Voltage Comp. Range	+15%/-15% up to 100% output
Regulation	+/-3%
Soft Start Period	20 Seconds to reach 100% output
Voltage Limit Range	5-100% of max load voltage.
Ambient Temperature Range	0 to 70 $^{\circ}$ C
Power Supply Voltage	24VAC +15/-15%
Power Consumption	65mA (Power consumption 1.6W MAX)
Line Frequency Range	47-63 Hz
Terminal Block wire Gauge	16-30 AWG
Terminal Block Material	Polyamide 6.6 UL 94 V-0, Black

## 6. Mechanical Dimensions

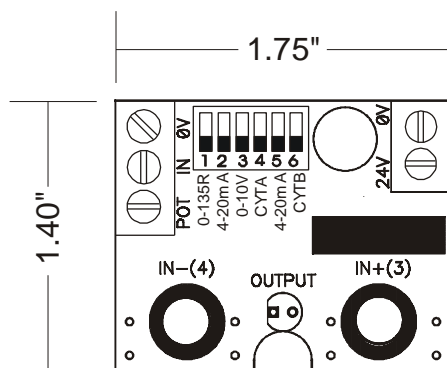

Max Height is 0.6"

## 7. Contact Information

NuWave Technologies, Inc  
 866-379-3597  
[www.nuwaveproducts.com](http://www.nuwaveproducts.com)

### 8. WIRING DIAGRAM (4-20mA, 0-5V, 0-10V Inputs)

SSRMAN-1P WIRING DIAGRAM (4-20mA, 0-5V, 0-10V INPUT)

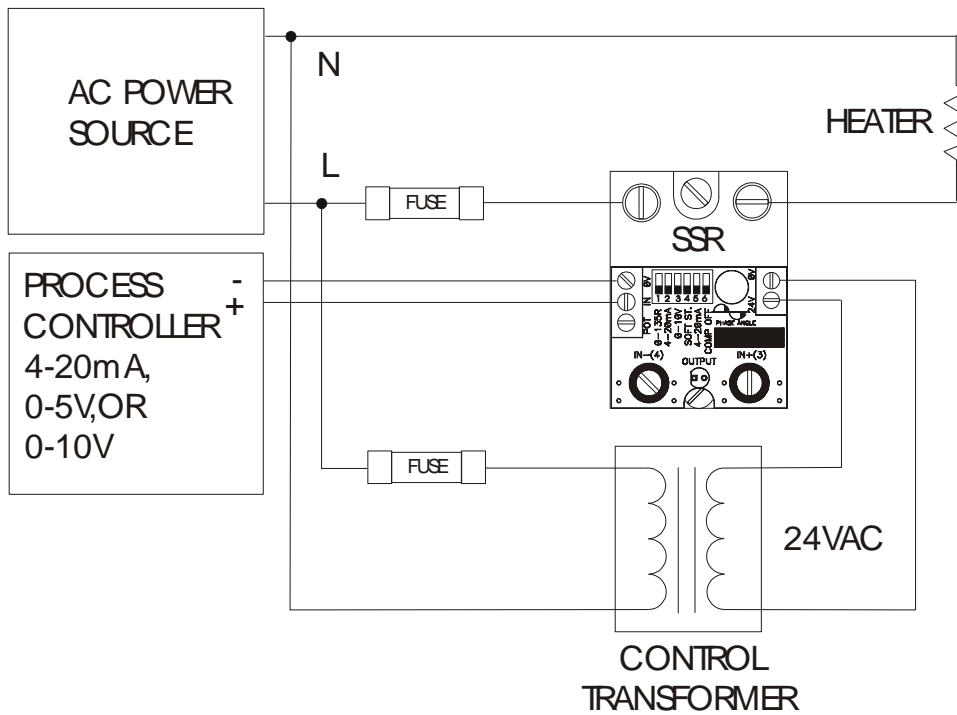

### 9. WIRING DIAGRAM (Potentiometer Input)

SSRMAN-1P WIRING DIAGRAM (POTENTIOMETER INPUT)

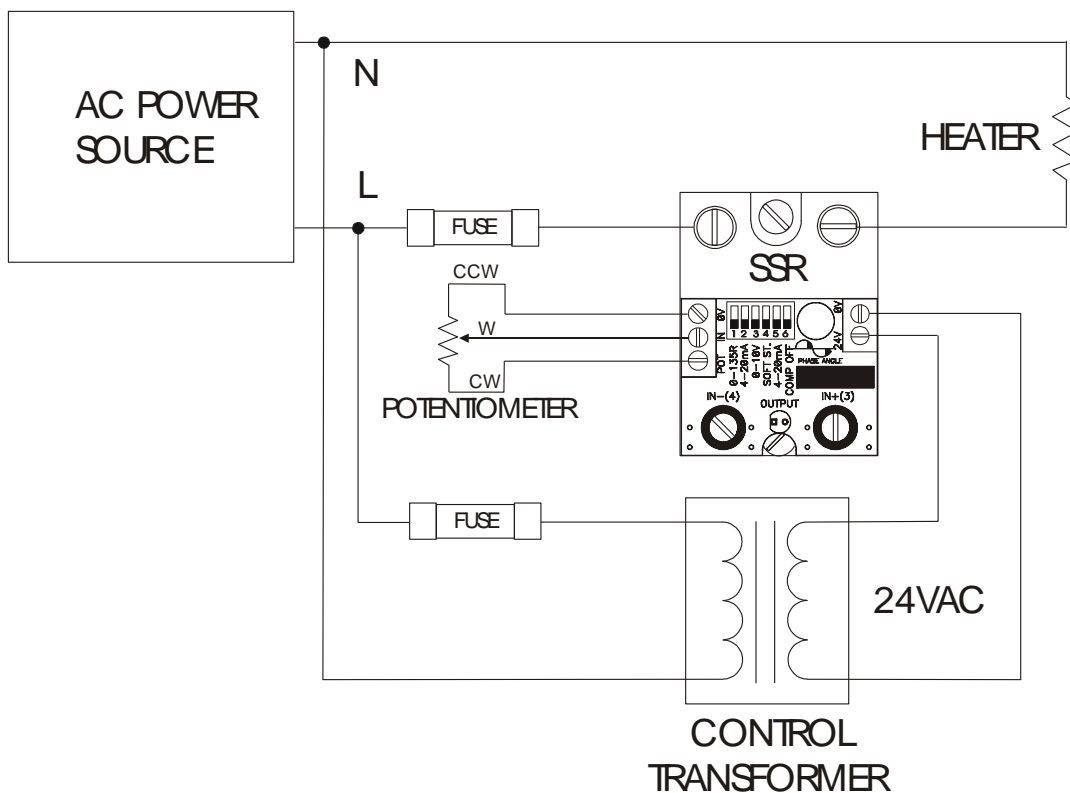

### 10. WIRING DIAGRAM (0-135 Ohm Input)

SSRMAN-1P WIRING DIAGRAM (0-135 Ohm Input)

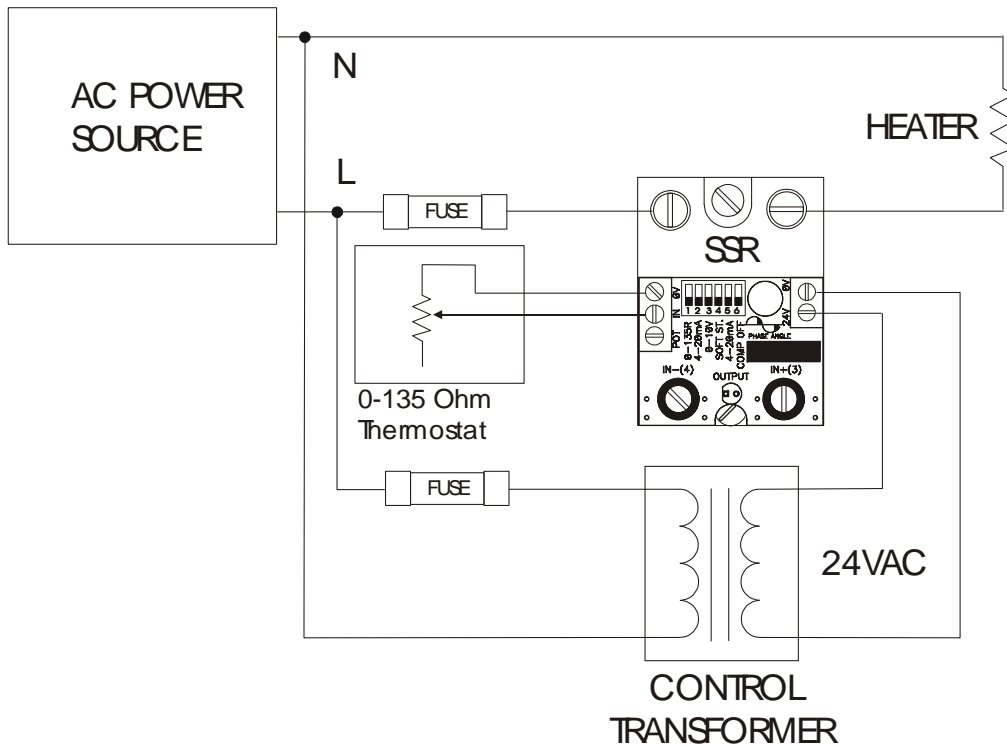

### 11. WIRING DIAGRAM (PWM Input)

SSRMAN-1P WIRING DIAGRAM (PWM INPUT)

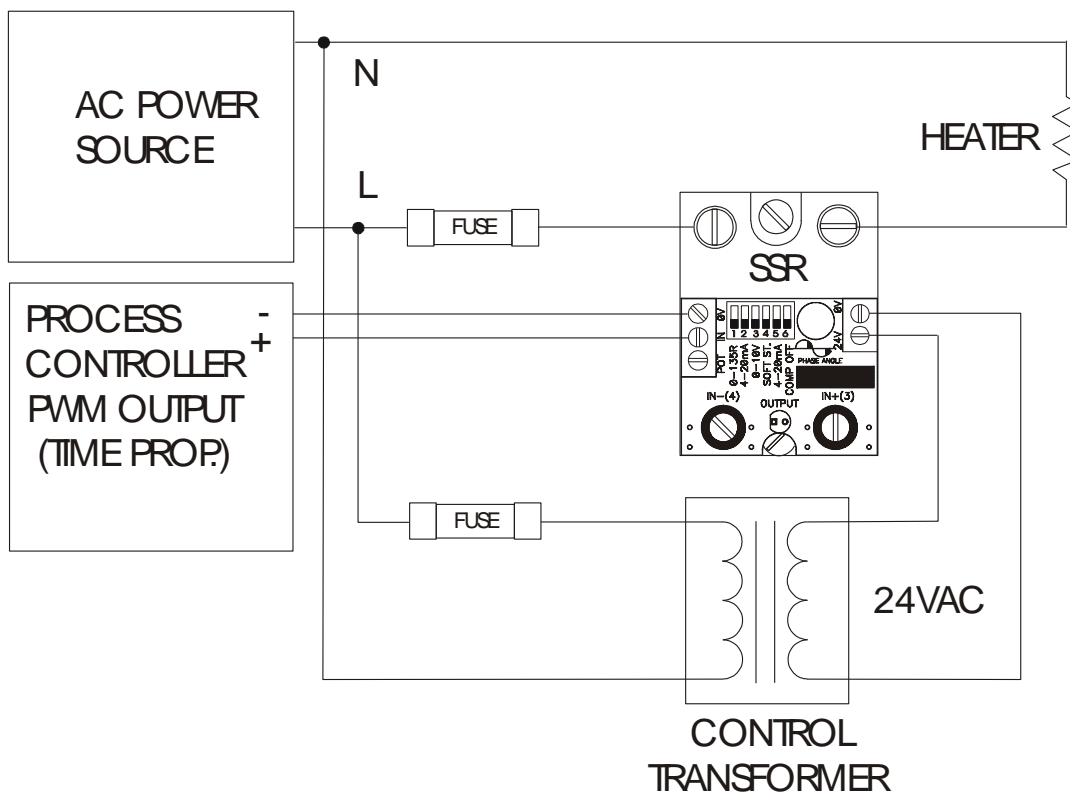

### 12. WIRING DIAGRAM 3 PHASE 4 WIRE Y CONNECTION

### SSRMAN-1P WIRING DIAGRAM 3 PHASE 4 WIRE Y CONNECTION

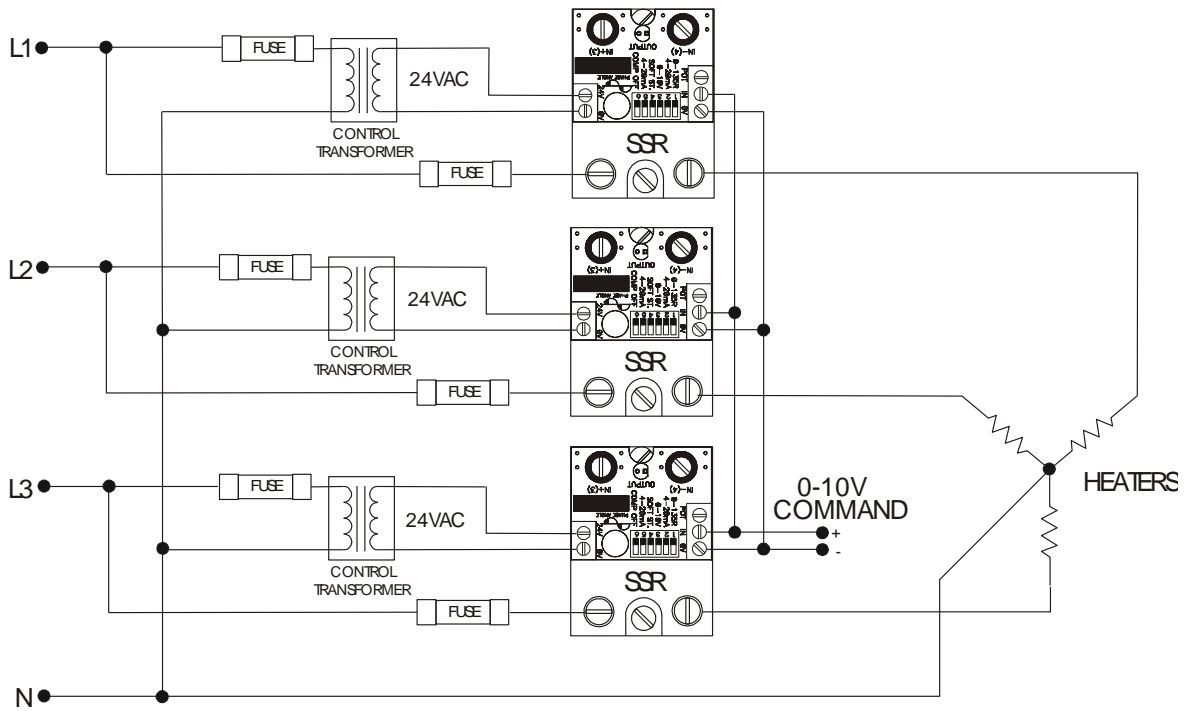

### 13. WIRING DIAGRAM 3 PHASE INSIDE DELTA

#### SSRMAN-1P WIRING DIAGRAM 3 PHASE INSIDE DELTA CONNECTION

